

# Digital Anemometer Instruction Manual



-01-

## A. Function

1. Measurement of wind speed and temperature
2. Wind cold indicator
3. Switch wind speed units
4. Real-time measurement of wind speed and average wind speed
5. Measurement of maximum wind speed and minimum wind speed
6. Switch between Fahrenheit and Celsius unit
7. Timed automatic shutdown (automatic shutdown after 10mins of no button operation)
8. LED lighting
9. Measurement of air volume

## B. Instruction of parts and LCD display

(1). Instruction of parts (as shown in picture)

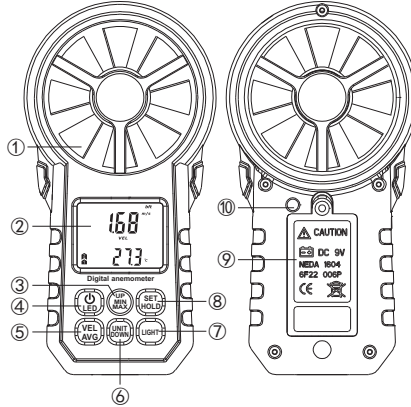

- ①.Fan blades
- ②.LCD display
- ③.Up/Maximum/Minimum mode
- ④.Power/backlight
- ⑤.Average wind speed measurement
- ⑥.Switch of wind speed units/ Down
- ⑦.LED lighting
- ⑧.Data holding/Setting
- ⑨.Battery door
- ⑩.LED lighting

-02-

(2).Instruction of LCD display (as shown in picture)

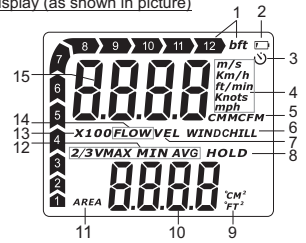

1. Beaufort wind scale
2. Low battery indicator
3. Timing automatic shutdown indicator
4. Wind speed unit:m/s, km/h, ft/min, knots, mph
5. Air volume unit: CMM, CFM
6. Wind cold indicator
7. Wind speed icon
8. Data holding
9. Temperature unit & area unit
10. Temperature display area
11. Area value
12. Two-thirds of maximum wind speed/maximum/minimum /average wind speed
13. X10 times, X100 times (X10 appears when the value exceeds 99.99, X100 appears when the value exceeds 999.99)
14. Air volume icon
15. Wind speed / air volume display area

## C. Operation instruction

- 1. Power on/off:**  
After installing batteries, press "ON" button to turn on the instrument, LCD display comes in full screen for 1s, and the buzzer lets out two beeps (if the buzzer is on); the instrument enters normal measurement mode of real-time wind speed and temperature. Long press "OFF" button for at least 2s to turn it down.
- 2. LCD backlight:**  
After powering on, press "LIGHT" button to turn on/off LCD backlight.
- 3. Maximum/minimum mode:**  
Under normal mode, press "MAX/MIN" button to enter measurement mode, which measures maximum and minimum wind speed in real time. Short press "MAX/MIN" button again to return to normal mode.
- 4. Data holding:**  
Under normal mode, press "HOLD" button to hold wind speed value when "HOLD" appears on the LCD; short press "HOLD" button again to return to normal mode.
- 5. Measurement of average wind speed:**  
Under normal mode, short press "AVG" button to switch to measurement of average wind speed, which is the average value of 30 current wind speed values, and "AVG" icon appears on the LCD; short press "AVG" button again to return to normal mode.

-03-

### 6. Selection of wind speed unit:

Short press "UNIT" button to select different wind speed unit in turn.

### 7. LED lighting:

Under normal mode, short press "LIGHT" button to turn on/off LED lighting.

### 8. Setting of temperature unit:

Long press "SET" button for 2s to enter setting mode; "ELE" icon appears on display area of wind speed, indicating that the temperature measurement mode is on. Short press "UP/DOWN" to switch to Celsius unit, short press "UNIT" to switch to Fahrenheit unit and the corresponding temperature value will display. Long press "HOLD" button for 2s to save setting and return to normal mode. (the setting is automatically saved if the instrument shuts down)

### 9. Automatic shutdown setting:

Long press "HOLD" button for 2s to enter setting mode. short press "HOLD" button again until "OFF" appears on display area of wind speed, indicating that automatic shutdown setting is on. Short press "ON/OFF" button to turn on timing shutdown, and short press "UP/DOWN" button to turn off timing shutdown. Long press "HOLD" button for 2s to save setting and return to normal mode. (the setting is automatic saved if the instrument shuts down)

### 10. Buzzer setting:

Long press "SET" button for 2s to enter setting mode. Short press "HOLD" button twice to until "BU2" appears on display area of wind speed, indicating that the buzzer setting is on. Short press "ON/OFF" button to turn on buzzer, short press "UP/DOWN" button to turn off buzzer. Long press "HOLD" button for 2s to save setting and return to normal mode. (the setting is automatically saved if the instrument shuts down)

### 11. Air volume display setting:

Long press "VEL AVG" button for 2s to enter air volume display mode. The current air volume value appears on the display area of wind speed, and the current set area value appears on the display area of temperature(as shown in picture).

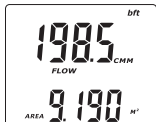

At this time:

- Long press "SET" button for 2s to enter setting mode of area value. Short press "LIGHT" to select setting, short press "UP" to add 1, short press "DOWN" to deduct 1, and the maximum setting value is 9999; short press "VEL AVG" button to

-04-

adjust position of decimal point, and long press "HOLD" button for 2s to save setting and return to display mode of air volume.

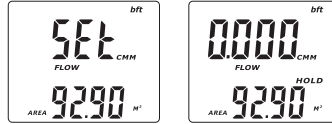

- Long press "VEL AVG" button for 2s to return to display mode of wind speed.

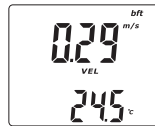

- Short press "VEL AVG" button to display "AVG" to indicate the average wind speed value. Press "VEL AVG" button again to display "2/3VMAX" to indicate that the current air volume value is 2/3 of the maximum value. Short press to return to normal reading value under display mode of air volume.

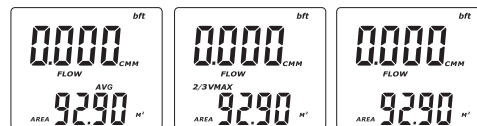

- Short press "MAX/MIN" button to switch between maximum and minimum mode of air volume.

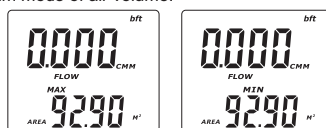

- Short press "UNIT" button to switch between CMM /CFM —M2/FM2.

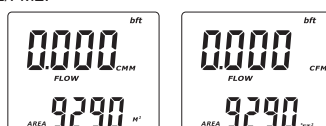

-05-

- Short press "HOLD" button to hold the air volume data.

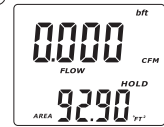

## D. Technical Parameters

A. Wind velocity measurement				
Unit	Measurement range	Resolution	Threshold	Accuracy
m/s	0~30	0.01	0.3	±5% ±0.1
ft/min	0~5860	1.968	60	±5% ±2.0
knots	0~55	0.019	0.6	±5% ±0.2
km/h	0~90	0.036	1	±5% ±0.4
mph	0~65	0.022	0.7	±5% ±0.2
B. Wind flow range :				
CMM: 0-999900m <sup>3</sup> /min		CFM: 0-999900ft <sup>3</sup> /min		
Unit	Range	Resolution	Area	
CFM(FT <sup>3</sup> /MIN)	0-999900	0.001-100	0.001-9999	
CMM(M <sup>3</sup> /MIN)	0-999900	0.001-100	0.001-9999	
C. Wind temperature measurement				
Unit	Measurement range	Resolution	Accuracy	
°C	-10°C~+45°C	0.1	±2°C	
°F	14°F~113°F	0.2	±3.6°F	
Battery	9V battery (6F22)			
Temperature sensor	Negative Temperature Coefficient Resistance			
Operation temperature	-10°C~+45°C(14°F~113°F)			
Operation humidity	Less than 90%RH			
Storage temperature	-10°C~+50°C(14°F~122°F)			
Current consumption	About 6mA			
Weight	184g(including battery)			
Size	165x85x39mm			

Specific Declarations:

Our company shall hold no any responsibility resulting from using output from this product as a direct or indirect evidence. We reserves the right to modify product design and specification without notice.



-06-